

Source Four jr and Source Four jr Zoom

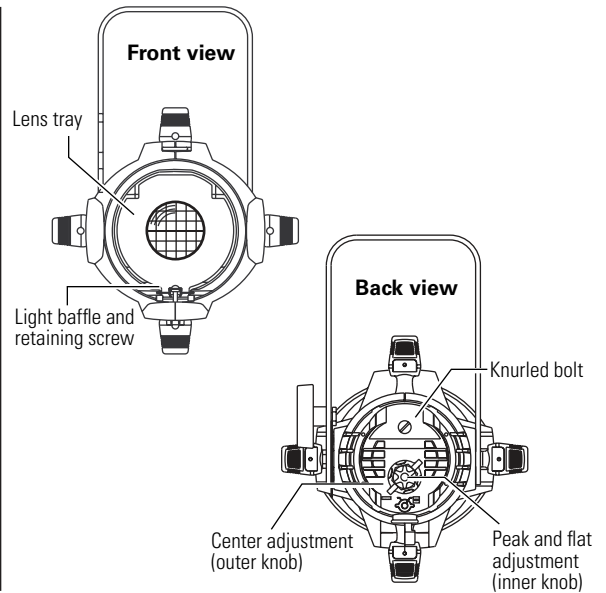
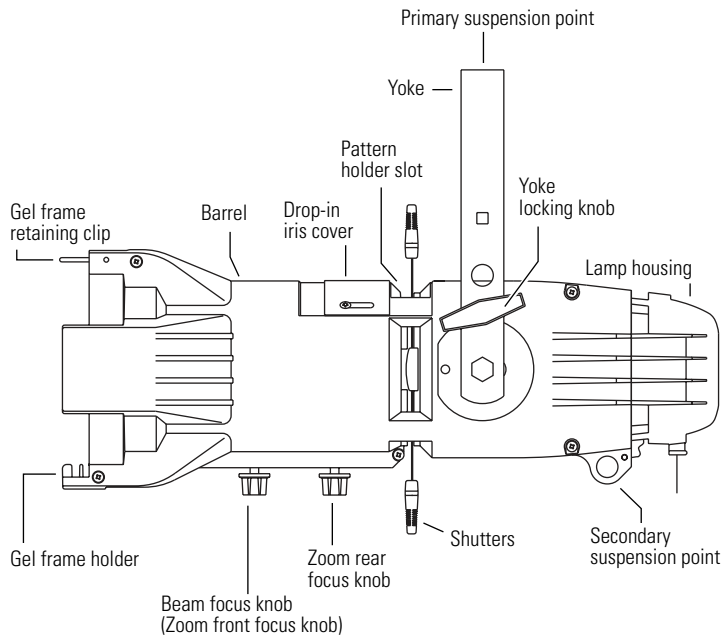

Adjusting the C-clamp

The C-clamp attaches the fixture to the mounting pipe and allows you to adjust the position of the fixture once it is mounted.

1. Tightly fasten the C-clamp to the yoke with the yoke bolt and lock washer.
2. Place the C-clamp on mounting pipe, then tighten the pipe bolt to secure it.
3. Loosen the C-clamp pan screw and rotate the yoke to the desired position.
4. Tighten the pan screw to lock the fixture into position.

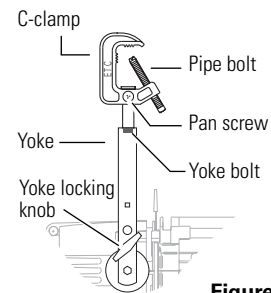

Figure 1

Adjusting the yoke

To adjust the fixture's position, loosen the yoke locking knob and tilt the fixture to the desired position. Retighten the yoke locking knob to secure it.

Source Four jr/Zoom's two-position yoke allows you to modify the overall height of the fixture in the yoke.

1. To change the yoke position, remove the yoke locking knob, then remove the hex bolts on either side of the fixture.
2. Move the fixture to the desired position (**Figure 2**).
3. Replace and tighten the hex bolts and the locking knob.

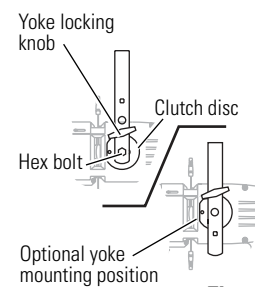

Figure 2

Color frame retaining clip

The color frame holder is equipped with a spring-loaded retaining clip that prevents color frames and accessories from falling out of the holder.

Caution! Always hang Source Four jr/Zoom with the color frame retaining clip in the locked position.

1. Release the retaining clip by pushing it sideways. The retaining clip will pop open.
2. Insert the color frame.
3. Press the retaining clip down until it locks into position.

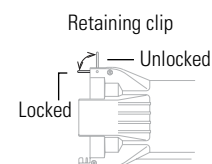

Figure 3



HPL lamps

HPL lamps are tungsten halogen lamps.

Verify that the HPL lamp you use is suitable for the voltage at your facility. 230V and 240V HPL lamps are available. Operating HPL lamps above their rated voltage reduces lamp life and can cause premature lamp failure.

WARNING! Do not use lamps other than the HPL in Source Four jr/Zoom fixtures. **Use of lamps other than HPL will void UL and cUL safety conformity and warranty.**

	Lamp code	Watts	Volts	Color temperature	Average rated life
American	HPL 375/115	375	115	3,250°K	300 hour
	HPL 375/115X	375	115	3,050°K	1,000 hour
	HPL 550/77	550	77	3,250°K	300 hour
	HPL 550/77X	550	77	3,050°K	2,000 hour
	HPL 575/115	575	115	3,250°K	300 hour
	HPL 575/115X	575	115	3,050°K	2,000 hour
	HPL 575/120	575	120	3,250°K	300 hour
Euro.	HPL 575/230	575	230	3,200°K	400 hour
	HPL 575/240	575	240	3,200°K	400 hour

Installing the HPL lamp

The lamp must be installed before you use the fixture.

Caution! Always replace the lamp if it becomes damaged or thermally deformed.

1. Disconnect the unit from power before installing and replacing the lamp.

WARNING! Let lamp cool before changing.

2. Loosen the knurled bolt on the back of the lamp housing and pull the housing straight out.

3. Remove the HPL lamp from its box, holding it by the base.

Note: To avoid premature lamp failure, do not touch the lamp glass. If you do touch the lamp, clean it carefully with rubbing alcohol and a clean, lint-free cloth before operation.

4. Line up the flat sides of the lamp base with the retention brackets on either side of the socket. See **Figure 4**.
5. Push down on the lamp base until the lamp seats firmly. (The top of the lamp base will be even with the top edges of the retention brackets when it is properly installed.)

Caution! Improperly installed lamps cause premature lamp failure and socket problems.

6. Press lamp retainers down across lamp base and clip securely.
7. To reinstall the lamp housing, line up the side fins and the bolt hole, then tighten the knurled bolt to secure the housing.

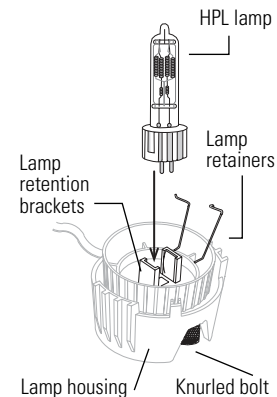

Figure 4

Aligning the lamp

Use the two concentric knobs on the rear of the lamp housing to align the lamp. The outer knob centers the lamp within the reflector and locks it in position; the inner knob fine tunes the field. See **Figure 5**.

Note: The fixture must be on to align the lamp.

1. Unlock the outer knob by turning it counterclockwise one turn.
2. Gently push the outer knob from side to side and up and down until the lamp is centered in the field.
3. Once the lamp is centered, tighten the outer knob to lock it in place.
4. Turn the inner knob right or left to adjust for optimum flat field.

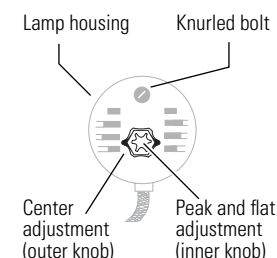

Figure 5

Focusing the beam

On a fixed field angle Source Four jr, with a 26°, 36° or 50° lens, adjust the lens position to focus the edge of the beam. On a Source Four jr Zoom, adjust the position of both lenses to set the beam's spread and to focus the edge of the beam. The Zoom lenses give you a range from 25° to 50°.

1. Loosen the beam focus knob(s) on the underside of the barrel. See **Figure 6**.
2. Slide the lens(es) forward or backward to achieve the desired beam edge.
3. Once the fixture is focused, tighten the beam focus knob(s).

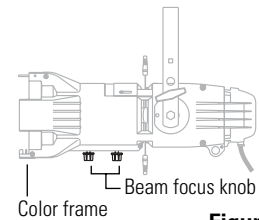

Figure 6

Gel notes

For best results, always use a high quality, high temperature color medium. ETC does not guarantee performance with low temperature, saturated color gels.

Shaping the beam

You may shape the beam with the shutters, a pattern, or an optional drop-in iris (ETC part #7062A1011). See **Figure 7**.



Figure 7

Pattern projection

The pattern holder slot is on the top side of the barrel, immediately in front of the shutters. It accommodates the M-size pattern holder shown in **Figure 8**. The M-size pattern holder's handle should bend away from the shutter handle at a 30° angle. If your pattern holder's handle is straight, you may bend it far enough to not interfere with the action of the shutter handle.

Use an optional donut (ETC part #7060A1037) in the accessory holder to enhance pattern projection.

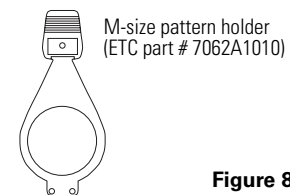

Figure 8

Drop-in iris slot

The drop-in iris slot is on the top side of the front barrel, immediately in front of the pattern holder slot. See **Figure 9**. When it is not in use, a small sheet metal cover secured with two crosshead screws prevents light leakage and retains the iris assembly. To install an iris, follow these steps.

Caution! Be certain the fixture is not hot before installing the iris.

1. Use a crosshead screwdriver to loosen the screws on the drop-in iris slot cover. Do not remove the screws.
2. Slide the cover completely forward, exposing the slot.
3. Insert the iris. The flat side must be toward the shutters and the iris handle should extend out of slot.
4. Slide the slot cover back toward the shutters until it meets the iris handle. Leave enough space to move the iris handle. Tighten the screws.

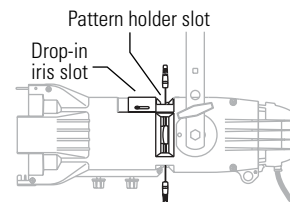

Figure 9

Switching lens assemblies

Follow these steps to replace a fixed field angle lens with Zoom lenses.

1. Loosen the screw at the front of the light baffle. See **Figure 10**.
2. Pull the light baffle out of the barrel.
3. Remove the beam focus knob from the bottom of the barrel and slide the lens assembly from the barrel.
4. Slide the Zoom lens rear assembly into the barrel and install its beam focus knob.
5. Slide the Zoom lens front assembly into the barrel and install its beam focus knob.
6. Slide the light baffle back into place.
7. Replace and tighten the screw at the front of the light baffle.

Note: Reverse this procedure to replace Zoom lenses with a standard lens.

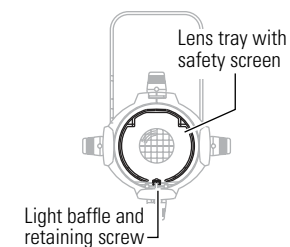

Figure 10

Cleaning lenses

Caution! Change lenses if they become visibly damaged to the extent that their effectiveness is impaired, for example, by cracks or deep scratches.

1. Remove the lens assembly. (See **Switching lens assemblies**, above, steps 1-3.).
2. Remove safety screen.
3. Dampen a clean, lint-free cloth with vinegar or household ammonia. You may also use water, but it will leave spots which you may remove by polishing the lens gently with a clean, dry cloth.

WARNING! Never use glass and window cleaner or any abrasive material to clean lenses. Glass and window cleaners will stain the lens surface. Abrasive materials (such as steel wool) will damage lenses.

4. Starting from the center, gently wipe the lens.
5. Replace safety screen.
6. Replace the lens assembly.

Accessories

Pattern holder, M-size	400PH-M
6.25" (15.875cm) donut	400DN
6.25" (15.875cm) top hat	400SN
6.25" (15.875cm) color frame	400CF
Drop-in iris assembly	400JRS
30" (76.2cm) safety cable, black	400SC
C-clamp	400CC
50° lens assembly	450JL
36° lens assembly	436JL
26° lens assembly	426JL
Zoom lens front assembly	42550FLT
Zoom lens rear assembly	42550RLT
Zoom lens assembly set	42550ZLS
Color extender	400GE

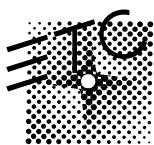

Electronic Theatre Controls

North America 3030 Laura Lane • Middleton, Wisconsin 53562 • USA • Tel: (+1) 608 831 4116 • Fax: (+1) 608 836 1736

Europe 5 Victoria Industrial Estate • Victoria Road • London W3 6UU • Tel: (+44) 181 896 1000 • Fax: (+44) 181 896 2000

Asia Room 605-606 • Tower III • Enterprise Square • 9 Sheung Yuet Road • Kowloon Bay • Hong Kong • Tel: (+852) 2799 1220 • Fax: (+852) 2799 9325

World Wide Web: <http://www.etconnect.com> • **Email:** mail@etconnect.com

Specifications subject to change. Source Four jr and Source Four jr Zoom are protected by US patent numbers 5,446,637 and 5,268,613. Japanese Patent 2,501,722.

US and International Patents Pending. 7062M1001.

Copyright 1998

Revised 11/98.